

Ø10mm

60 G-90 1F

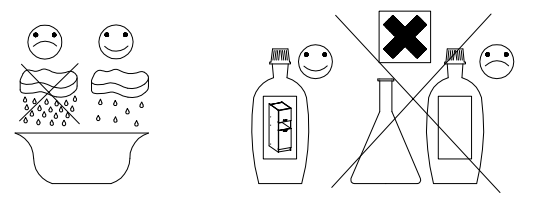

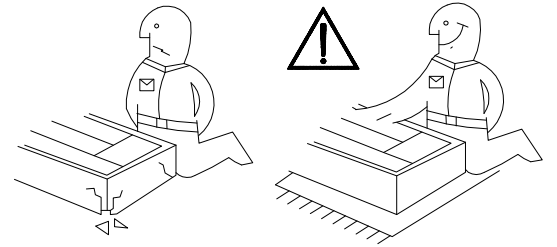



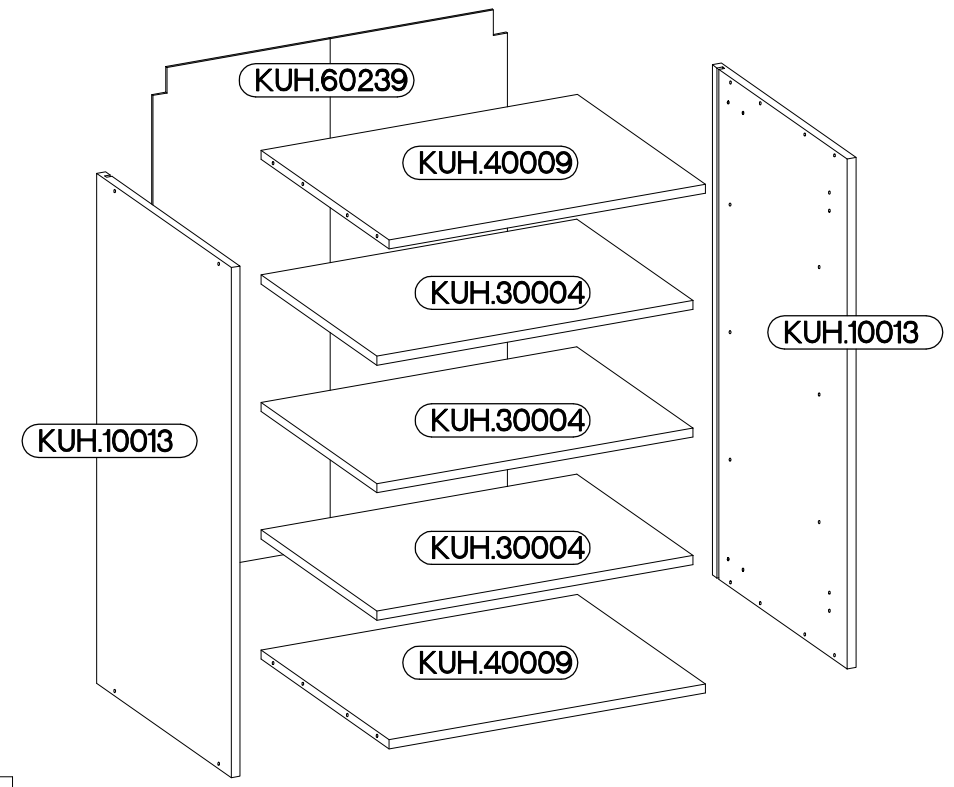
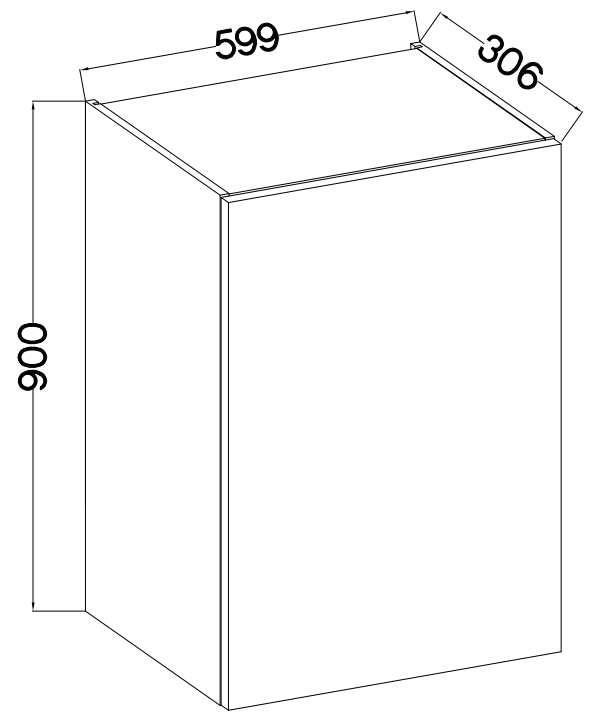
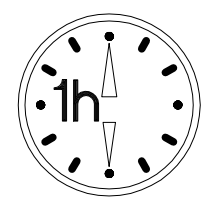

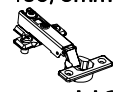

max.
5kg

KUH.30004
KUH.40009



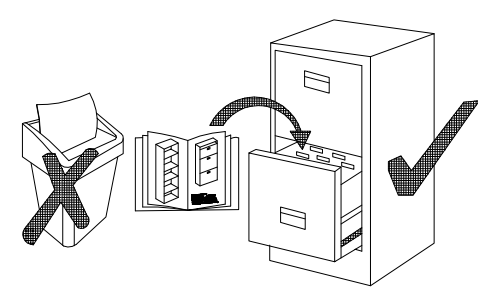

Ersatzteil Nummer	Dimension
KUH.10013 x2	900x290x16
KUH.30004 x3	566x250x16
KUH.40009 x2	567x276x16
KUH.60239	896x585x2,5

 A	 B	 E1	 HG			
8	8	8	2			
 J	 K	 O	 P5	 P7	 P8	
12	2	1	4	8-10	4	



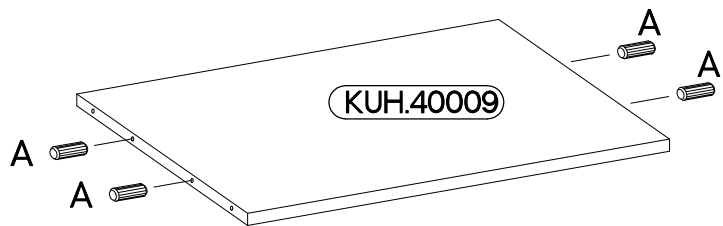
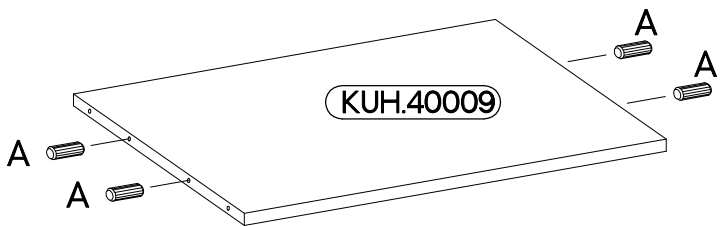
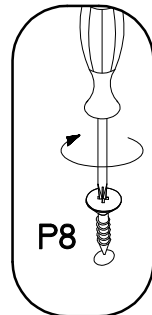
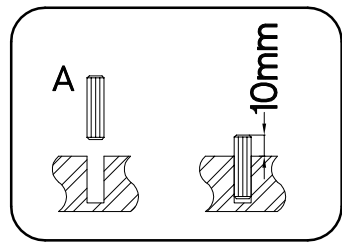
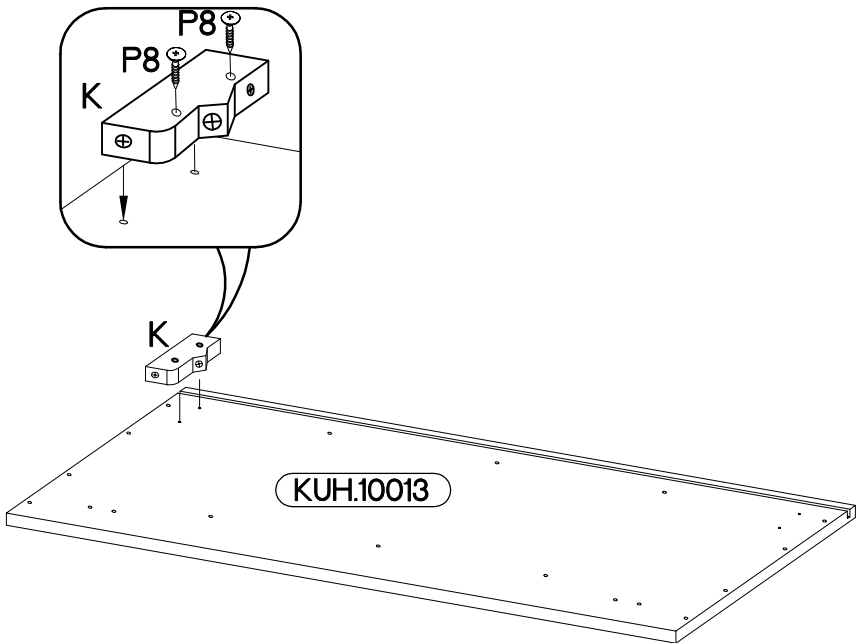
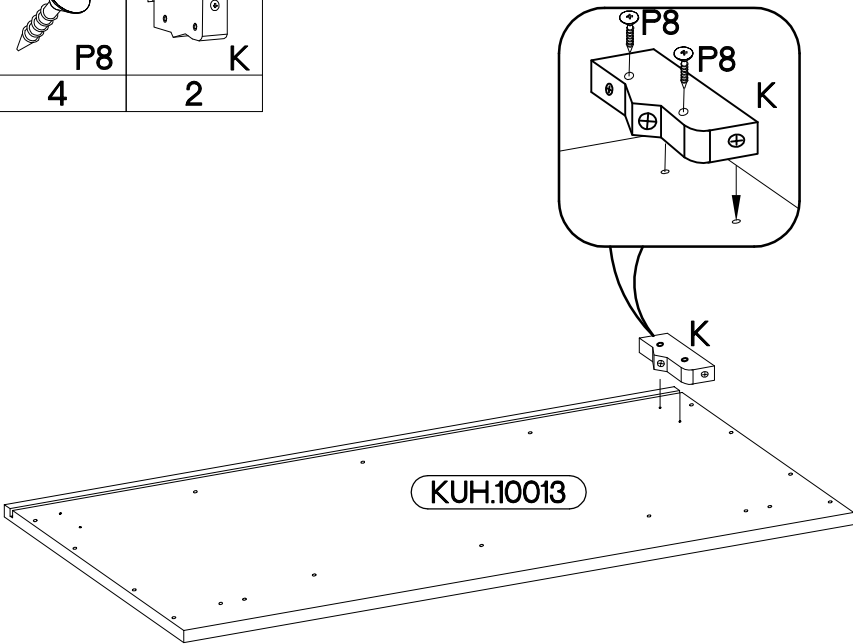
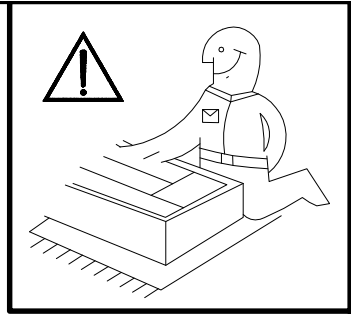

ISM-KUH-01130

 ø8x30mm A	 ø4.0x30mm P8	 K
8	4	2



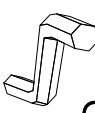

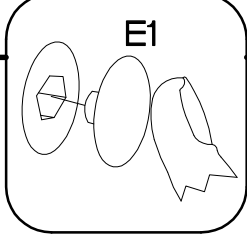
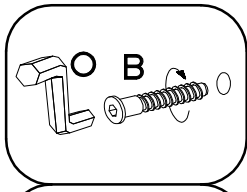
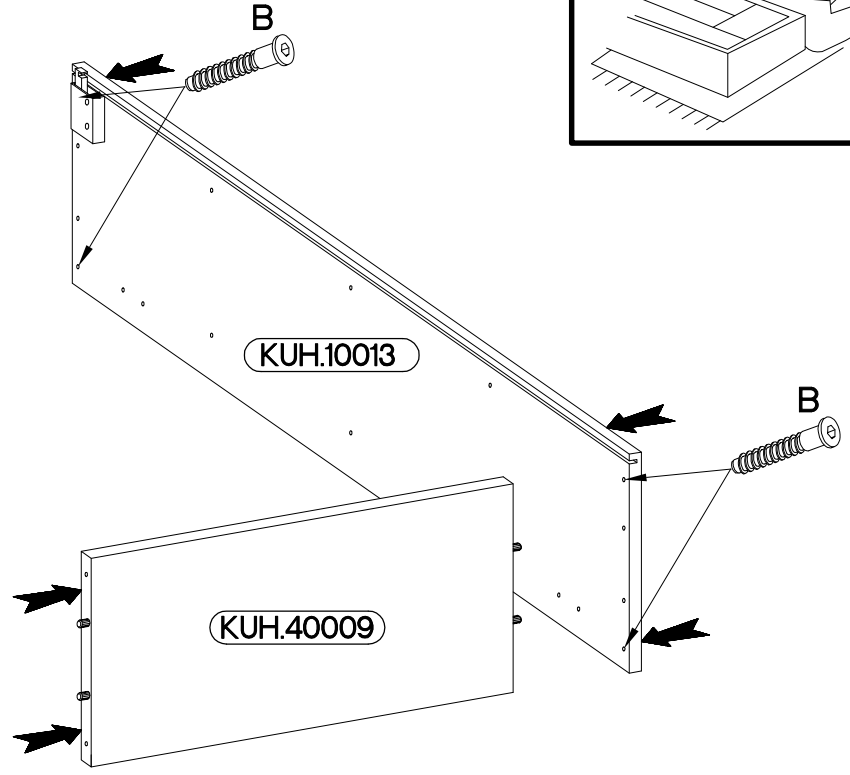
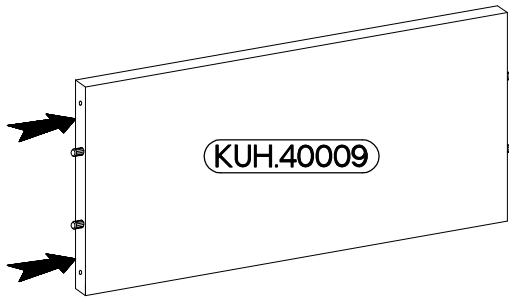
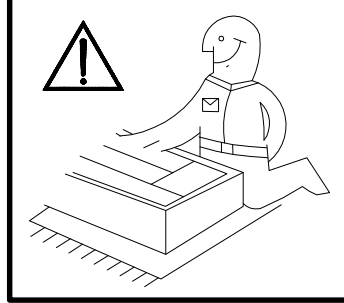

2

6,4 x 50mm		
		
B	O	E1
4	1	4

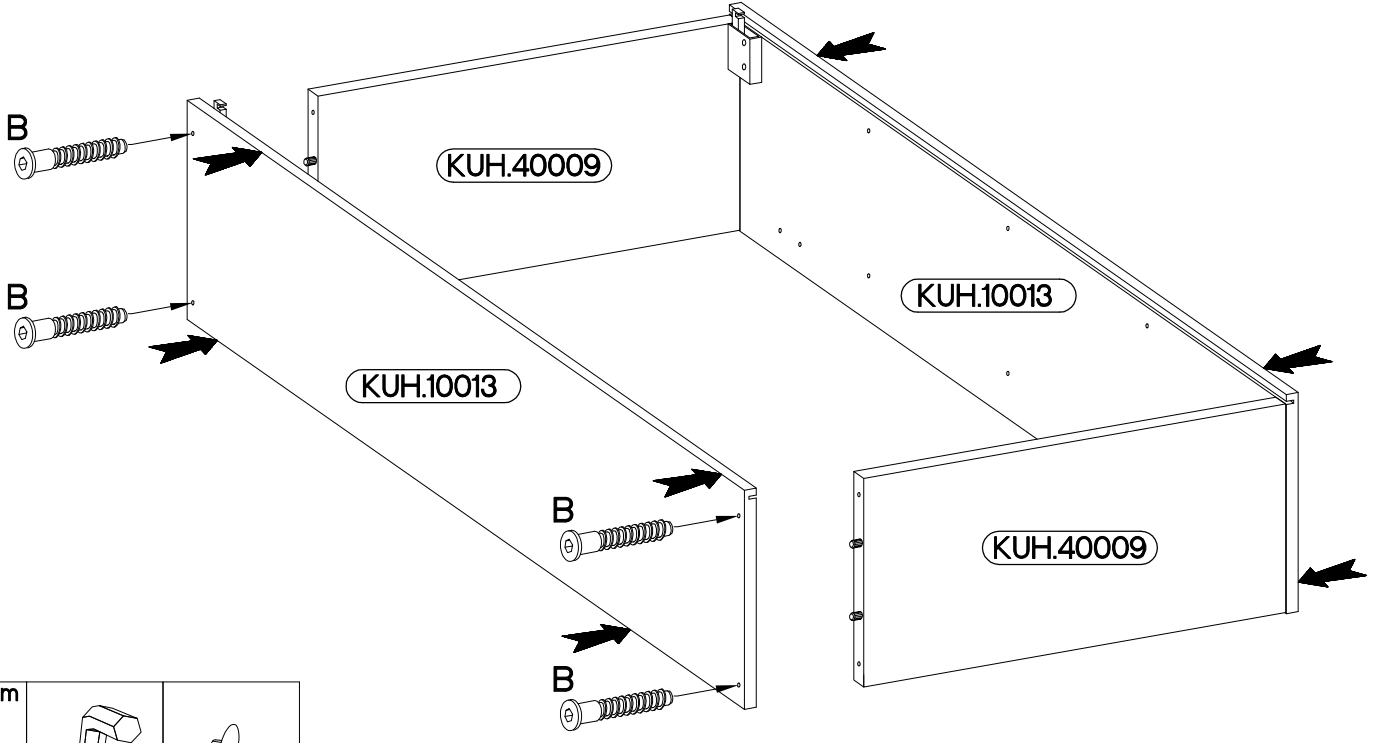

3

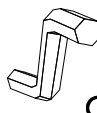

6,4 x 50mm		
		
B	O	E1
4	1	4

4

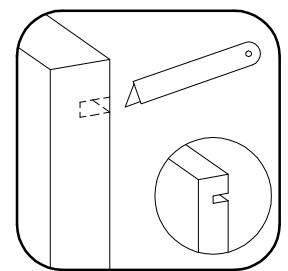
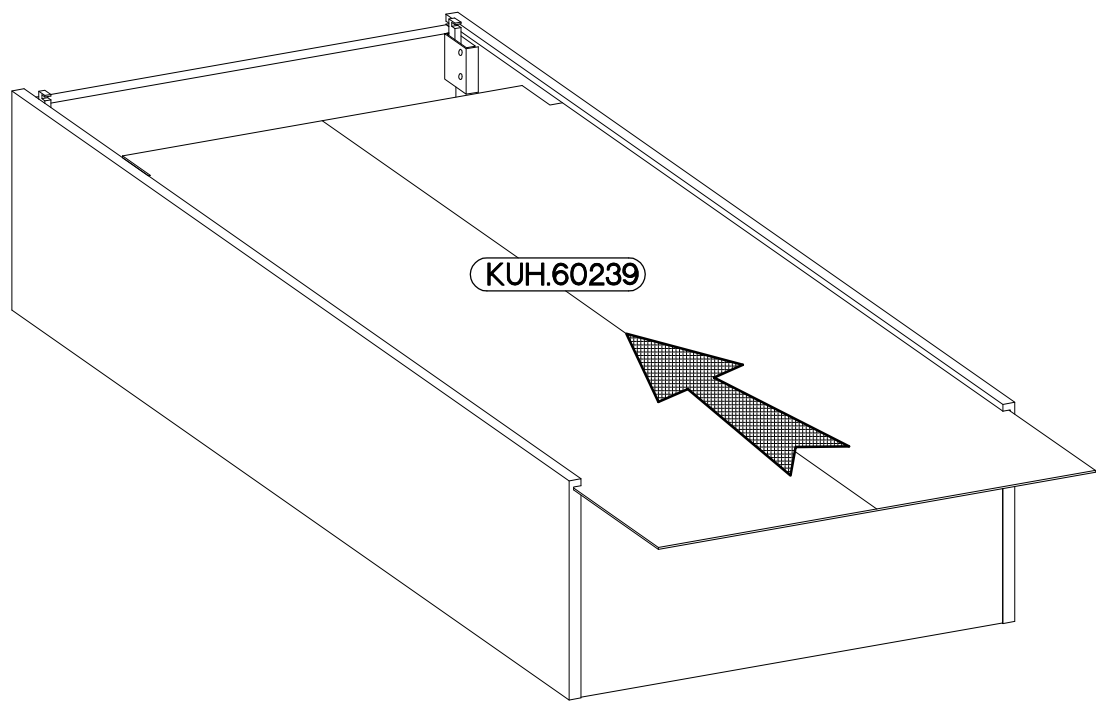
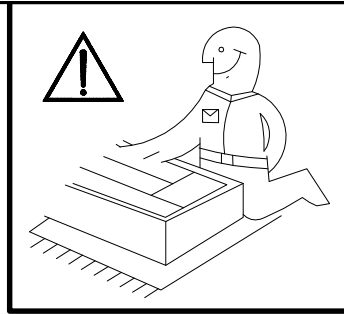

5

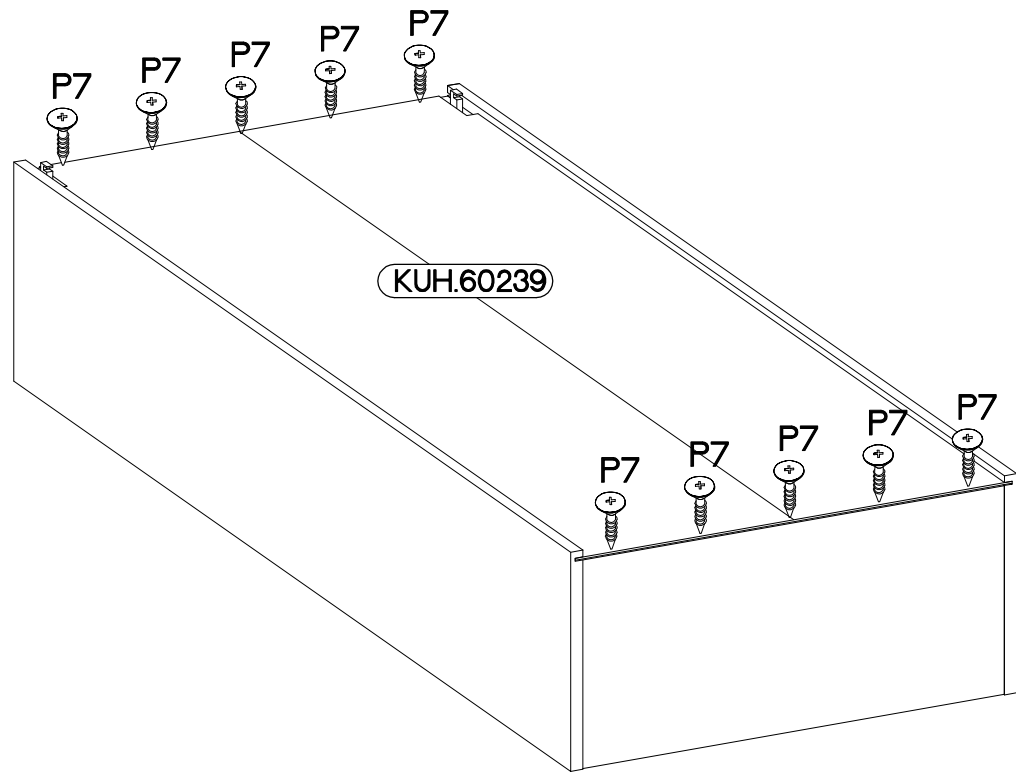
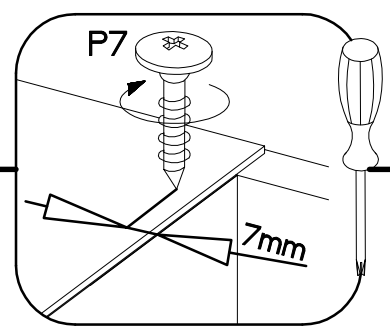
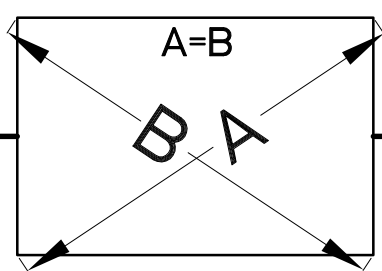
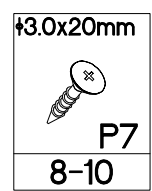

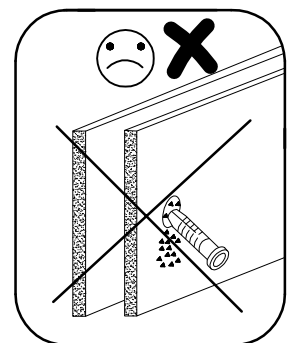
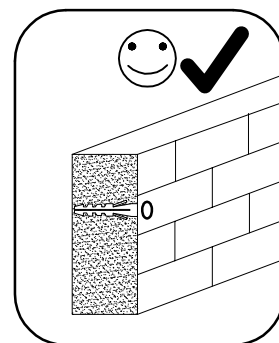
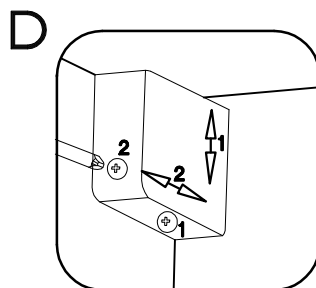
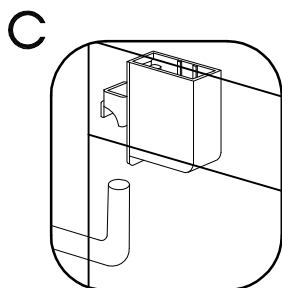
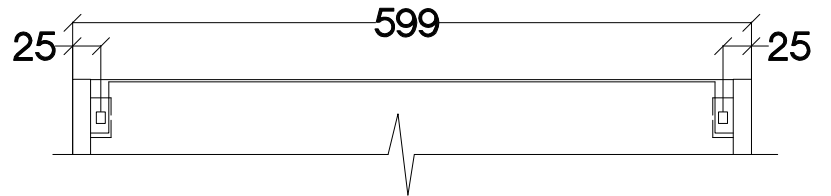
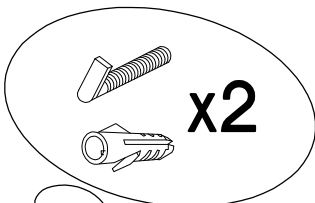
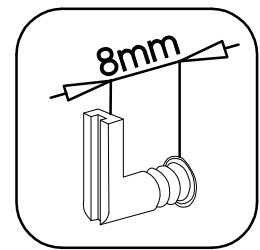
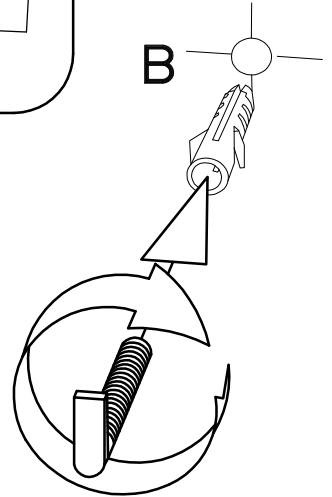
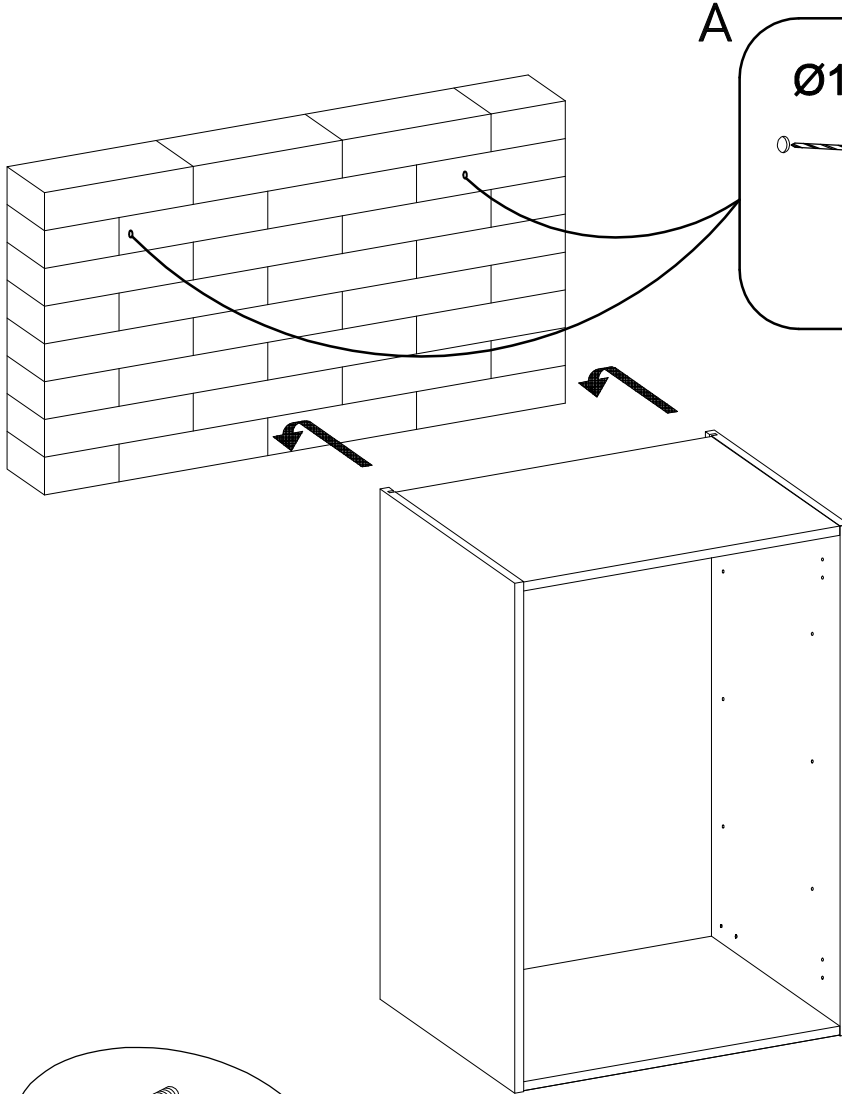
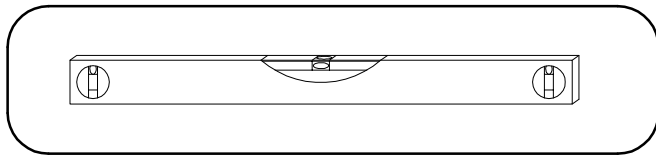

7

±5/19mm
J
12

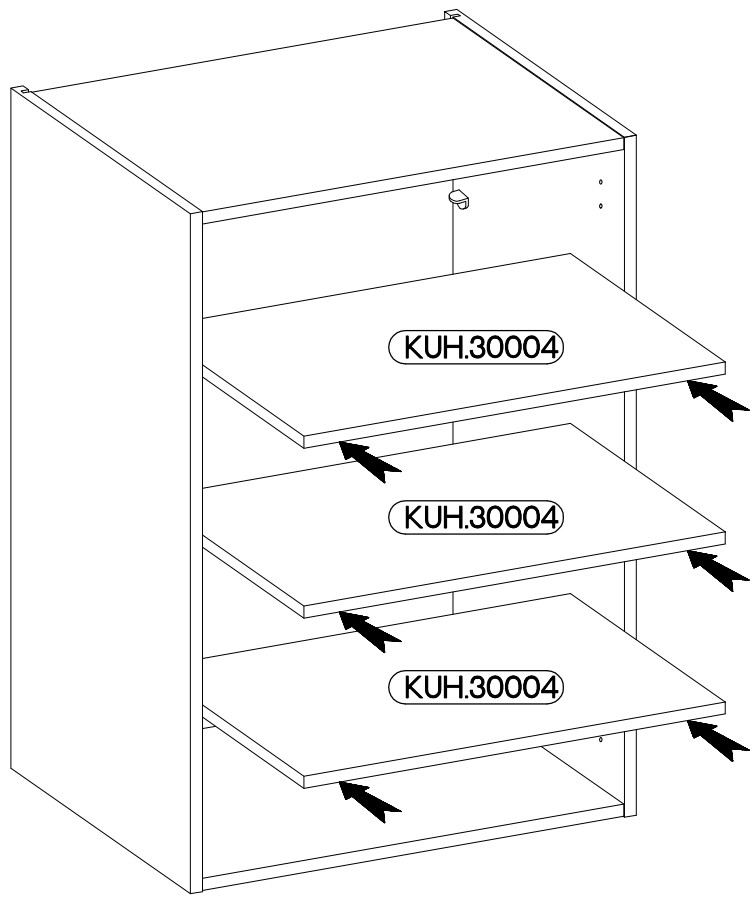
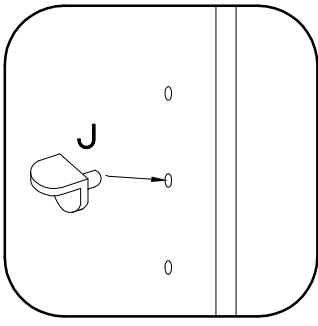

8

FRONT

